

ALPS SERIES

Installation manual



ALPS BA5.2 LITHIUM-ION BATTERY

V1.1 | 12/06/24

1 Notes

- 1.1 Basic overview
- 1.2 Personnel requirements

2 Safety

- 2.1 Basic security
- 2.2 Emergency responses

3 Storage and transportation

- 3.1 Storage requirements
- 3.2 Transportation requirements

4 Product introduction

- 4.1 Product description
- 4.2 Label description

5 Installation

- 5.1 Installation environment
- 5.2 Pre-installation inspection
- 5.3 Packaging list
- 5.4 Installation required tools
- 5.5 Basic installation requirements
- 5.6 Electrical connection
- 5.7 Installation instructions
- 5.8 Battery parallel

6 Troubleshooting

7 Datasheet

8 Appendix

1.1 Basic overview

This document describes the installation, electrical connection, operation, commission, maintenance and troubleshooting of the Polar ESS ALPS battery system.

Before installing and operating the ALPS battery, ensure that you are familiar with the product features, functions, and safety precautions we've provided here.

1.2 Personnel requirements



CAUTION

This manual is intended for qualified electricians who are trained to deal with the dangers and hazards involved in installing electrical equipment.

Personnel requirements:

- Qualified electrician
- Knows how to deal with the hazards and risks associated with the installation and use of electrical equipment
- Trained in the installation and commissioning of electrical equipment
- Understands all applicable standards and guidelines
- Understands and follows this manual and all safety instructions

**CAUTION**

Safety information contained in this section must be observed at all times when working on or with batteries. For safety, installers must familiarise themselves with this manual and all warnings before installation.

2.1 Basic security

The battery has been designed and tested strictly in adherence with international safety certification requirements. Read all safety instructions carefully before any work and follow the rules at all times when working on or with the battery. Polar ESS shall not be liable for any consequence caused by the violation of the following:

- Damage occurred during transportation
- Incorrect transportation, storage, installation and use, or a failure to convey the correct information about transportation, storage, installation, and use to end users
- Non-professional installation
- Failure to follow the guidance laid out in the operation instructions and safety precautions in this document
- Unauthorised modifications or removal of the software package
- Battery tamper label is damaged or product has any part missing (except authorised accessory components)
- Operation in extreme environments which are outside of operating parameters
- The repair, disassembly, or changing of batteries without authorisation
- Damage to shell labels or modified date of production
- Failure to charge the battery for more than six months
- Damages due to force majeure (such as lightning, earthquakes, fire, and storms)
- Warranty expiration

2.1.1 Environmental requirements

- Do not expose the battery to temperatures above 50° or place near heat sources
- Do not install or use the battery in wet locations, or where it may be exposed to moisture, corrosive gases, or liquids
- Do not expose the battery to direct sunlight for extended periods of time
- Place the battery in a safe place away from children and animals
- Battery power terminals must not touch conductive objects such as wires
- Do not dispose the batteries in fire, which may cause an explosion
- The battery must not come in contact with liquids

2.1.2 Operation precautions

- Do not touch the battery with wet hands
- Do not disassemble the battery without permission
- Do not crush, drop or puncture the pack and battery
- Dispose the batteries according to local safety regulations
- Store and recharge the battery in accordance with this manual
- Ensure the connection of ground wire
- Remove all metal objects such as watches and rings that could cause a short-circuit before installation, replacement and maintenance
- The battery must be repaired by qualified personnel
- When storing or handling batteries, do not stack batteries without appropriate racking
- Do not puncture the battery; the released electrolyte may be toxic and is harmful to skin and eyes
- Packaged batteries should not be stacked more than the specified number stipulated on the packing case
- Do not use damaged, failed or deformed batteries, which may lead to high temperature or even dangerous accidents. Continued operation of a damaged battery may result in electrical shock or fire

2.2 Emergency responses



WARNING

The manufacturer has taken foreseeable risk scenarios into consideration. The product is designed to reduce hazards and dangers. However, if any of the following emergency situations occur, do as below.

Situation occurs	Description and action need
Leakage	Avoid contact with leaking liquid or gas. If you do come into contact with the leaking electrolyte, do as below immediately. Inhalation: Evacuate the contaminated area, and seek medical help. Eye contact: Rinse eyes with flowing water for 15 minutes, and seek medical help. Skin contact: Rinse contacted area thoroughly with soap and water, and seek medical help. Ingestion: Vomit, and seek medical help.
Fire	It's hard for battery systems to ignite spontaneously. If the battery has caught on fire, do not try to extinguish the fire but evacuate people immediately. Do not use water-based extinguishers.
Wet batteries	If the battery is flooded or submerged, do not access it. Contact Polar ESS or your distributor for technical assistance immediately.
Damaged batteries	Damaged batteries are dangerous and must be handled with special attention. They are no longer suitable for use and may cause danger to people. If the battery is damaged, stop using it immediately and contact Polar ESS or your distributor.

3.1 Storage requirements



CAUTION

Safety information contained in this section must be observed at all times when working on or with batteries. For safety, installers must familiarise themselves with this manual and all warnings before installation.

- Store the battery in accordance with the instructions provided on the packaging
- Do not put the battery upside down or sidelong
- The defective battery needs to be separated from other batteries

The storage environment requirements are as follows:

1. Install the battery in a dry and clean place with proper ventilation
2. The storage temperature for a short week is between -30°C to 60°C
3. If you store the battery over a long period of six months, the storage temperature is between -20°C to 50°C relative humidity: 5%~95%RH
4. Place the battery away from corrosive and organic substances (including gas exposure)
5. The battery should be free from direct exposure to sunlight and rain
6. Place the battery at least two meters away from heat sources (such as a radiator)
7. Ensure the battery is free from exposure to intensive infrared radiation



NOTE

Stock batteries should be replenished and maintained every six months. If the battery is stored in a warehouse for more than 2 months, it should be recharged before delivery.

1. Identify the battery that needs recharging and remove the batteries to be recharged from the packing case
2. Connect the battery to the inverter
3. Discharge the battery to SOC=0%
4. Charge the battery to SOC=25%
5. After recharging, place the batteries back in the original carton and seal

3.2 Transportation requirements



CAUTION

Please refer to the following requirements for battery transportation. Failure to comply with these requirements can void the product warranty.

- The battery must not be transported with other inflammable, explosive or toxic substances
- Ensure the original package and label are kept from damage
- Prohibit direct exposure to sunlight, rain, condensing water caused by temperature differences and mechanical damages
- Do not stack up more than six batteries
- There will be a drop in capacity during transportation and storage
- Transportation temperature is between -20°C to 50°C, relative humidity: 5%~95%RH

4.1 Product description

The ALPS battery is an energy storage unit composed of electrochemical cells, switch button, battery management unit, power and signal terminals, and mechanical parts. It features better charge and discharge performance, more precise status monitoring, longer cycle life, and less self-discharge loss than other batteries. Connect up to 5 batteries in parallel to increase the capacity and power of the battery system. The whole battery system communicates to the inverter via CAN.

- **Monitoring:** Voltage, current, and temperature detection of both single cells and battery
- **Protection and alarm:** Protection and alarm when overvoltage, under voltage, over current, over-temperature or under temperature occurs. See appendix I for details
- **Report:** Report all alarm and status data to inverter
- **Parallel connection:** Support two to five batteries in parallel connection
- **Passive balance function**

4.1.1 Battery overall view

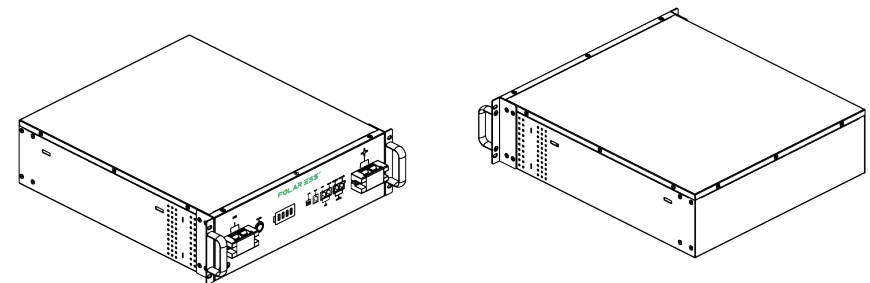

4.1.2 Battery dimensions and interface view

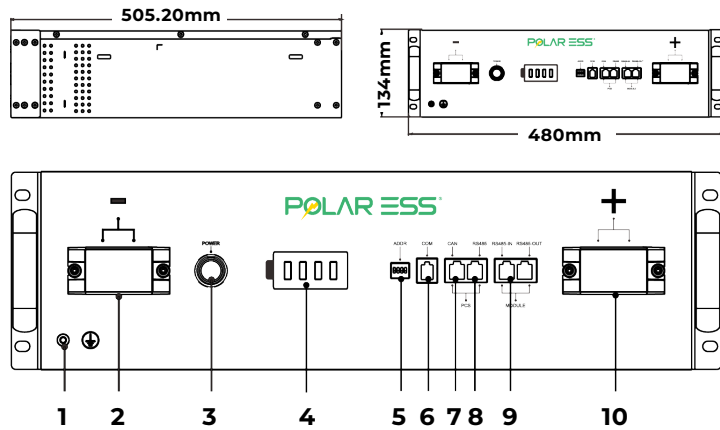

Interface view

Location	Port	Function
1	PE	Terminal connect to ground
2	Pack-	Battery output-
3	Battery button	Battery on or off
4	SOC LED	SOC and status display panel
5	DIP switch	Setting for battery ID
6	RS232 6P	Connect to PCS
7	CAN 8P	Connect to inverter
8	RS485 8P	Connect to inverter
9	Battery RS485 8P	Connect to battery
10	Pack+	Battery output+

4.1.3 LED display description





No.	Name	Colour	Description	Example
1	SOC LED 1	Green	SOC 0%-25%	
2	SOC LED 2	Green	SOC 26%-50%	
3	SOC LED 3	Green	SOC 51%-75%	
4	SOC LED 4	Green	SOC 76%-100%	
5	Battery button	Green	Normal operation	
6	SOC LED	Red	Fault	

- Press and hold the battery button for 1s; the buzzer will sound for two seconds and the battery LED switch will be green
- Press and hold the battery button for 3s; the buzzer will sound for one second and the battery LED switch will dim
- The battery SOC; the corresponding SOC LED indicator will be green and off at intervals of 1S
- If the parallel is successful, the SOC LED will be green and off for 5S every 0.8S
- When the SOC ranges from 0% to 5%, LED1 will be displayed in green and off for 2s
- The SOC LED will be red-green twinkling

4.2 Label description

4.2.1 Model labels

Provide unique identification of the battery (product type, device-specific characteristics, certificates and approvals). The type label is located on the right side of the battery.

POLAR ESS [®] Li-ion Battery	
Model	ALPS BA5.2
Nominal Voltage	51.2Vd.c.
Rated Capacity	100Ah
Nominal Energy (25°C)	5120Wh
Battery Voltage Range	44.8~57.6Vd.c.
Max. Charging and Discharging Current	120A
Ingress Protection	IP20
Protective Class	Class I
Operating Temperature Range	0 ~ +50C for charge -10 ~ +50C for discharge
    Hazardous Waste	
Serial Number:	

4.2.2 Serial number

The battery serial number information is located on the right side of the battery.

SN: PBG XX X XXXX

↓ ↓ ↓ ↓
 1 2 3 4



Number	Paraphrase
1	Implication fixed coding
2	Year
3	Month
4	Journal number

WARNING

- Read the official guidance before installation in order to understand product information and safety cautions
- Installers should be qualified electricians and fully understand the whole photovoltaic system, grid network, working principle and national and regional standards
- Installers must use insulated tools and wear PPE
- Device damages caused by failure to comply with storage, transportation, installation and user requirements specified in our guidance are not covered by warranty

5.1 Installation environment

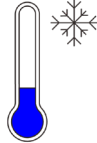
The ambient temperature for the installation of the battery system should be above -10°C, below 50°C, and the humidity should be between 5% and 95%.

 Max +50°C	 Min -10°C	 RH. +5% ~ +95%
--	--	---

5.2 Pre-installation inspection

Thoroughly inspect the packaging upon receipt. If any damage to the packaging is visible, or if you find that the unit is damaged after unpacking, please notify your supplier immediately. Try not to dispose of the original packaging. If you need to transport the unit, it is better done so in the original packaging.

5.3 Packaging list

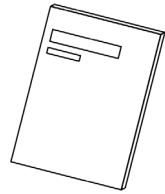

Quick guide manual x1

A

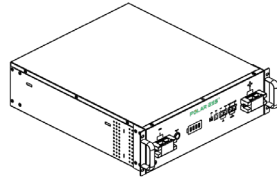

ALPS BA5.2

B



Positive parallel power cable X1
Negative parallel power cable X1
Parallel communication cable X1
Ground cable X1

C



Positive power cable x1
Negative power cable X1
Communication cable X1

D

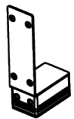

E



F



G

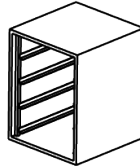

Please note: cables and pedestals are optional.

Installation method	Compound
Single battery installation (cabinet)	A+C+F
Stack installation (Single battery)	A+C+D
Stack installation (Multiple batteries)	A+B+C+D+E
Cabinet installation	A+B+C+F+G

5.4 Installation required tools

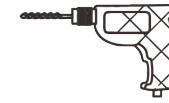

Drill (M4)



Screwdriver (M4)

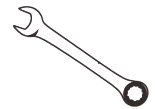

Socketset (M4)

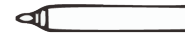

Pencil



5m tape measure



Multimeter

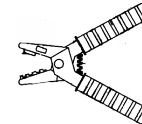

Cable stripper



RJ45 tool



Spirit level

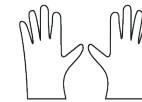

Insulated gloves



Safety goggles



Safety shoes

5.5 Basic installation requirements

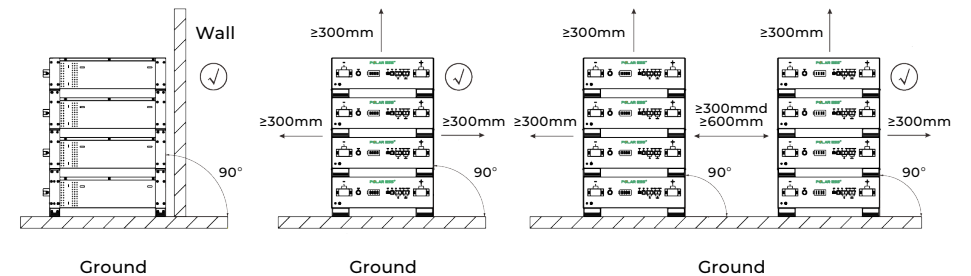

5.6 Electrical connection



CAUTION

Do not forget to wear ESD wrist strap and gloves, safety gloves, and goggles.

5.6.1 System connection diagram

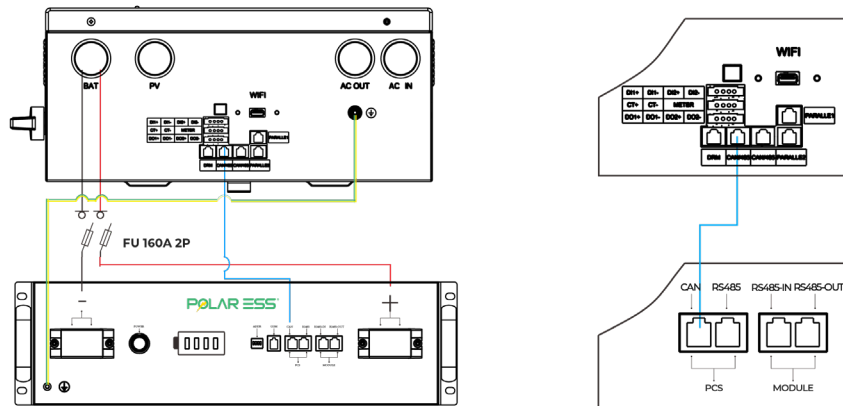

Please note: it is recommended to use a 3AWG power cable to connect the battery to the inverter.

Battery wiring

1. Set the battery DIP switch to the master
2. Connect the positive and negative terminals of the battery with the positive and negative terminals of the inverter with the power cables, and connect the communication cables



NOTE

- Do not install the battery whilst switched on
- To ensure system safety, do not forget to install ground wire
- There must be a breaker between the inverter and battery. We recommend using a molded case circuit breaker with a rated working voltage greater than 125V, and rated working current greater than 150A

5.7 Installation instructions

5.7.1 Stackable installation

Please note: foot support accessories are optional.

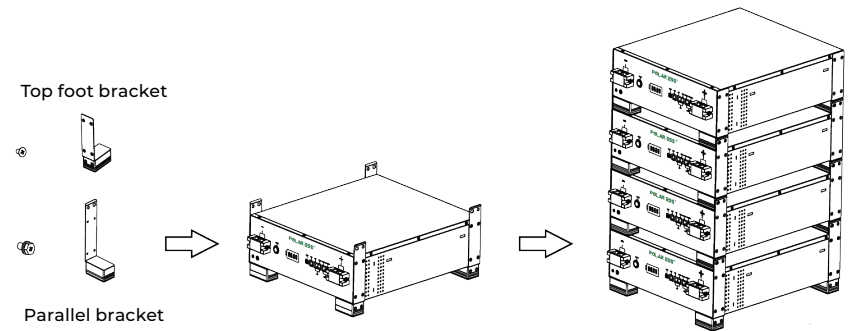

1. To install the battery stack together, prepare four battery feet with the provided screws. Secure the foot brace to the four corners of the battery. If you want to install four batteries, get three sets of bottom feet and one set of top feet. You can connect up to five at a time. We recommend that the stack number be no higher than five
2. After locking the foot brace to the battery, place the bottom battery where you plan to install it
3. Please note that if installing a single battery, only type A feet are needed; if multiple batteries then type B is used on all packs except the top
4. Secure the safety screws before you stack the next battery. After stacking all the batteries, select one battery and set its DIP switch to the master, and set the DIP switch of other parallel batteries to the slave
5. Connect power lines into battery terminals (red positive terminal and black negative terminal). Plug each battery's CAN communication line into the communication ports of the inverter and battery

5.7.2 Cabinet installation

Please note: standard cabinet is optional; handles are optional

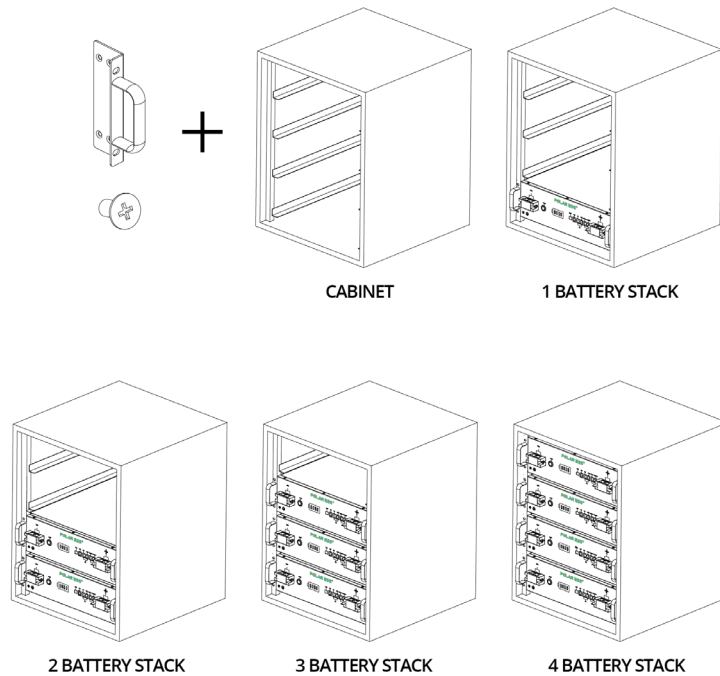

1. Install handles
2. Prepare a 19" standard cabinet and ensure that the bearing capacity of the cabinet is over 250kg. You can parallel up to 5 devices at a time
3. Place the batteries in the cabinet from the bottom up, and lock the parallel cables from the bottom up
4. Select one battery and set its DIP switch to the master, and set the DIP switch of other parallel batteries to the slave
5. Move the cabinet to where you want to place it, then install the power cable, communication cable and secure the cabinet
6. Connect power lines into battery terminals (red positive terminal and black negative terminal). Plug the CAN communication line into the communication ports of inverter and battery

5.8 Battery parallel

5.8.1 Connecting the communication cables between the Polar Inverter and associated battery packs

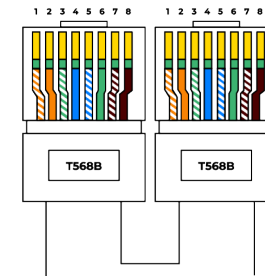

Using the pin out, connect a communication cable between the Polar Inverter (CAN/RS485 port) and the Polar Battery (CAN port), then from battery to battery using the RS485 (in/out ports).



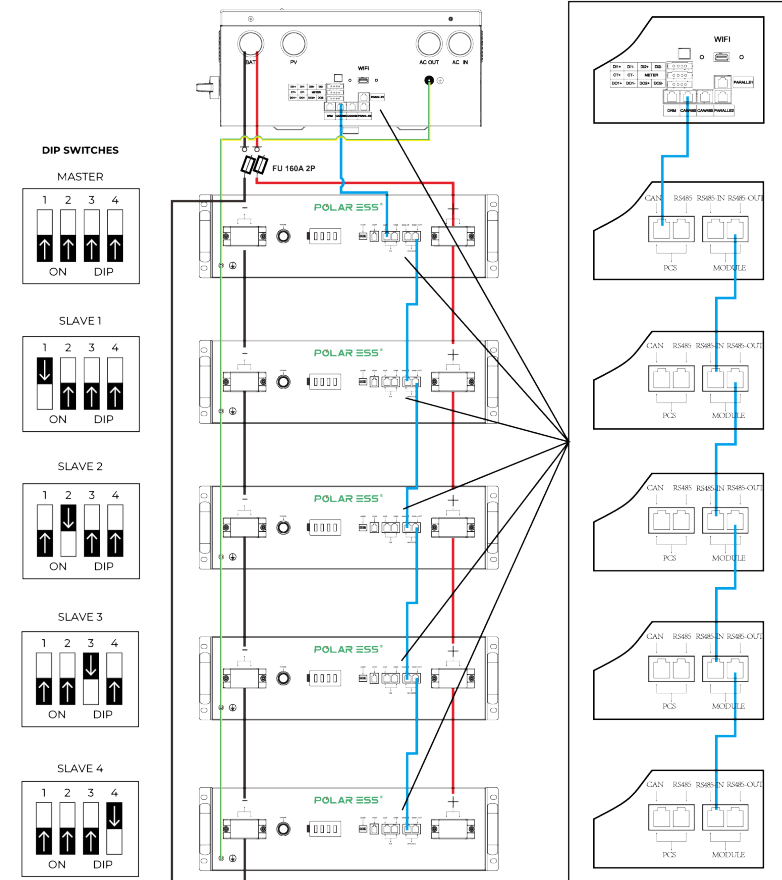

All power connections between batteries (red/black) must be wired according to the below diagram.

Diagram left: T568B pin out connections



5.8.2 Setting for battery ID

BAT5.2

Battery	Description	ID
Master		0,0,0,0
Slave1		1,0,0,0
Slave2		0,1,0,0
Slave3		0,0,1,0
Slave4		0,0,0,1

The switch in the up position is 0.













Battery parallel wiring:

1. Connect the parallel power cable, communication cable, and ground cable between batteries
2. Select one battery and set its DIP switch to the master, and set the DIP switch of other parallel batteries to the slave
3. Connect the positive and negative terminals of the master with the positive and negative terminals of the inverter with the power cables, and connect the communication cables

ERROR			
Error description	Error code	Suggested actions	
INDICATION	Discharge under voltage protection	Single cell voltage below the threshold for under-voltage protection	There is over discharge risk. The user should stop discharging and arrange a recharge
	Charge over voltage protection	Single cell voltage exceeding threshold for protection threshold	There is no safety threat. The user should stop charging and the idle battery will turn to normal status
	External CAN Communication failure	Communication loss between PCS and battery	There is no safety threat. The user should stop using the battery and check if the PCS and battery communication terminal is well-connected. If the PCS and battery cannot communicate when the communication wire is confirmed to be well-connected, the user should contact their installer
	Interior CAN Communication failure	Communication loss between two parallel	Check CAN connection between two batteries, and CAN connection between RS485 in and RS486 out
	Parallel connection failure protection	Communication failure between two parallel connected battery	Check CAN connection between two batteries, and CAN connection between battery and PCS
	Discharge short circuit	External short circuit of battery	There is a safety risk. The user should stop using the battery and contact their installer
	Precharger short circuit Precharger overtime circuit		
	Type inconsistency of battery	The battery type is different	There is a safety risk. The user should stop using the battery and contact their installer

Model	ALPS BA5.2
Voltage Range (Vdc)	48 ~ 57.6
Nominal Capacity (Wh)	5120
Usable Capacity (Wh)	4780
Charge/Discharge Current (A)	100
	360V
	>120 @ 15 secs
Depth of Discharge	92%
Communication Port	RS485, CAN, RJ45
Working Temperature (Charge)	0 ~ 50°C
Working Temperature (Discharge)	-20 ~ 60°C
Storage Temperature	-20 ~ 60°C
Protection Class	IP20
Humidity	5% ~ 95% (RH) No Condensation
Altitude	<4000m
Design Life	10+ Years
Cycle Life	6000 (25°C)
Standard	CE/UN38.3
Number of Parallel Batteries (Max)	5
Dimensions (D x W x H)	505 x 134 x 440 (mm)
Weight	45kg
Installation	Rack mounting or floor standing
IP Grade	IP20
Warranty	3 Years
Technology	LiFePO ₄

LED light definition						
Status	Items	SOC indication				Remark
		LED1	LED2	LED3	LED4	
Charge SOC	0%-25%	● t=1s				The battery SOC; the corresponding SOC LED indicator will be green and off at intervals of 1S
	26%-25%	●	● t=1s			
	51%-75%	●	●	● t=1s		
	76%-99%	●	●	●	● t=1s	
	100%	●	●	●	●	
Discharge SOC	100%-76%	●	●	●	●	No special display status
	75%-51%	●	●	●		
	50%-26%	●	●			
	25%-0%	●				
Idle	100%-76%	●	●	●	●	When the SOC ranges from 0% to 5%, LED1 will be displayed in green and off for 2s
	75%-51%	●	●	●		
	50%-26%	●	●			
	25%-5%	●				
	5%-0%	● t=2s				

Parallel connection	Parallel connection succeeds					If the parallel is successful, the SOC LED will be green and off for 5S every 0.8S
		t=0.8s	t=0.8s	t=0.8s	t=0.8s	
Discharge SOC	Cell charge overvoltage protection					SOC LED light red
	Battery charge overvoltage protection					SOC LED light red
	Over charge and over discharge protection					SOC LED light red
	Cell discharge undervoltage protection					SOC LED light red
	Battery discharge undervoltage protection					SOC LED light red
	Discharge short circuit					SOC LED light red
	Voltage sampling fault					SOC LED light red
	Charge/discharge overcurrent protection					SOC LED light red

